



<b>EAN:</b>	4013288196347	<b>Size:</b>	122x83x25 mm
<b>Part number:</b>	05078635001	<b>Weight:</b>	84 g
<b>Article number:</b>	7772 A	<b>Country of origin:</b>	TW
		<b>Customs tariff number:</b>	82079099

- För momentnycklar i serie Click-Torque X med 9 x 12 mm-hållare
- För 1/4" fyrkants-hylsmejselinsatser liksom 1/4" adaptrar med fyrkantsfattning
- Tätstegad mekanism med 72 tänder
- Enkel omkoppling med vred
- Hylsspärrfunktion med tryckknapp

Insats-spärnyckel, omkopplingsbar, för 1/4" fyrkant-hylsmejselinsatser samt 1/4" adaptrar med fyrkantsfattning, för momentnyckel i serie Click-Torque X med 9 x 12 mm-hållare.

**Web link**  
<https://www.wera.de/se/05078635001>

Wera - 7772 A  
05078635001 - 4013288196347

Wera Werkzeuge GmbH  
Korzter Straße 21-25  
D-42349 Wuppertal  
Tel: +49 (0)2 02 / 40 45-0  
E-Mail: [info@wera.de](mailto:info@wera.de)

Fattning 9 x 12 mm



För momentnycklar i serie Click-Torque X med 9 x 12 mm-hållare.

Kort returvinkel

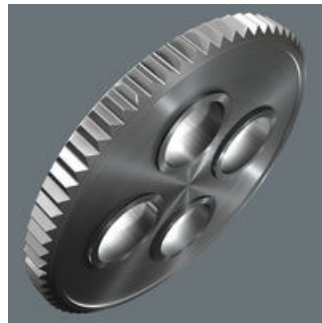

Tätstegad med 72 tänder för en returvinkel på bara 5°

1/4" ytterfyrkant

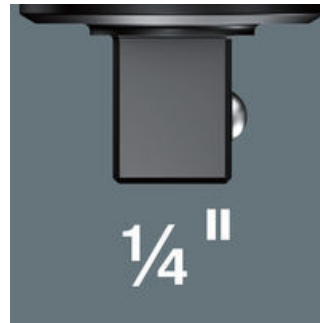

För 1/4" fyrkants-hylsmejselinsatser liksom 1/4" adaptrar med fyrkantsfattning.

Enkel omkoppling

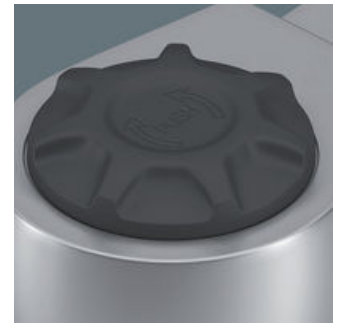

Enkel omkoppling med vred.

Säkert hylsspärr









Säker hylsspärr med tryckknapp

Krom-vanadin



Utförandet i krom-vanadinstål gör insatsverktyg lämpliga för stora belastningar.

Further versions in this product family:

							
	mm	inch	mm	mm	mm	mm	mm
05078635001	9x12	1/4"	17,5	48,6	32,0	27,9	24,7

Web link  
<https://www.wera.de/se/05078635001>

Wera - 7772 A  
 05078635001 - 4013288196347

Wera Werkzeuge GmbH  
 Korzter Straße 21-25  
 D-42349 Wuppertal  
 Tel: +49 (0)2 02 / 40 45-0  
 E-Mail: info@wera.de