



Manufacturer:

Zarges Kft - Factory Kecskemét, Hungary
6000 Kecskemét
Szent István krt. 19.

EN

N°

46005952

User Manual

Creaxess product

Contents

1	Information about this manual	3
2	Safety instructions	4
3	Technical description	7
4	Assembly	8
5	Usage	12
6	Maintenance and repair	13
7	Spare parts list	15

1 Information about this manual

This manual applies to the following product: Creaxess product

Henceforward: product. Reading, understanding and following these instructions are essential for the correct and safe use of the product. Failure to follow the instructions in this manual may result in death, injury or property damage.

The manual must be available at all times during assembly and use. It must be read and understood by all the people entrusted with any of the following tasks:

- transportation
- assembly
- usage
- inspection, cleaning, maintenance or servicing

When the product is transferred to a third party, the manual must always be given to the new owner.

In addition to the manual, the following conditions must be met:

- country-specific accident prevention regulations
- a recognized expert must check the technical specifications for safe and professional use

This document applies to the following manufactured and delivered product:

- customer order number: 11839931
- Zarges material number: 46005952

Legal notice:

The manufacturer is exempt from liability for any damage or injury caused by:

- Ignorance of the instructions and warnings in this document
- Inadequately trained or informed personnel
- Use of non-original parts
- Careless use of the product
- Unauthorized modification of the product

2 Safety instructions

Intended use of the product:

- indoor use
- climbing the ladder only to the maximum permitted safe height
- long work in which the product is moved several times
- work on the product with building materials and tools is also allowed, if the total load does not exceed the maximum allowed
- several people can be on the product, if the total load does not exceed the maximum allowed

Intended use also includes compliance with the operating and maintenance tasks specified by the manufacturer.

Improper use of the product:

Any use that does not fall under the 'Intended use of the product' section is considered improper. The operator is solely liable for any damage resulting from improper use.

The following are considered particularly improper use:

- outdoor use
- using the product as a bridge unless specified
- using the product as a base on which an additional ladder is placed, thus exceeding the maximum permitted height
- using the product to transport tools, materials or people

General safety:

The product is manufactured in accordance with modern and approved safety standards. However, the use of the product may pose a risk to the user's physical safety.



Danger

Use the product with consideration for your physical integrity and life! To avoid dangerous situations, the following conditions must be met:

- sufficient time to follow the rules
- use appropriate safety equipment if necessary
- do not leave the product unattended in a public place
- all work must be carried out with care
- check the integrity of the structure before using the product
- do not use the product if any parts are missing or damaged

2 Safety instructions



Inappropriate footwear

Injuries can occur if appropriate footwear is not worn when assembling, using and servicing the product.



Drugs, alcohol or medication

People are under the influence of alcohol, drugs or medication when moving the product, their reactions can be impaired. This can result in injury or damage.



Safety boots

If the prescribed safety boots are not worn while working, foot injuries can occur.



Danger area

If the necessary precautions are not taken, it can result in damage, serious injury or death



High voltage

If the necessary precautions are not taken, high voltage can cause damage, serious injury or death.



Explosive atmosphere

If the necessary precautions are not taken, the explosive atmosphere can cause damage, serious injury or death.



Heavy loads

If the necessary precautions are not taken, injuries can occur from lifting heavy loads.



Static electricity

If the necessary precautions are not taken, static electricity caused by cleaning with dry cloths can cause injury or damage.

2 Safety instructions



Fall hazard

If the necessary precautions are not taken, falling can result in serious injury or death.



Tipping loads

If the necessary precautions are not taken, injuries or damage can occur from lifting heavy loads.

3 Technical description

Scope of delivery:

The packaged condition may differ from the assembled condition, this depends on the order:

- before assembly, you must ensure that the contents of the order confirmation and the delivery note are present and that they are undamaged
- only flawless, original parts may be assembled
- if a part is missing, contact the manufacturer

Product marking:

For precise identification, the product has a nameplate.

The nameplate is glued to the side of the ladder rung.

Never remove the nameplate.

Technical data:

- product weight: 30 kg
- max. load capacity: 300 kg

The product was manufactured considering the following standards:

(Disclaimer: deviations from the applicable standards can occur due to the requested design by the customer)

- DIN EN 1999-1-1 (Eurocode 9)
- DIN EN ISO 14122-2
- DIN EN ISO 14122-3
- DIN EN 1090-3
- DIN EN 1004-1
- DGUV Information 208-016

4 Assembly

Safety instructions for assembly:

- assembly must be carried out in the specified order
- consult other people in case of heavy products
- the product or sub-assembly must be lifted, if necessary with lifting equipment
- never lift the product on steps, ladders or supports
- self-locking nuts can only be used once, in case of any repairs, new ones must be purchased
- compliance with the permitted torque of the screws, 24 Nm for M8, 93 Nm for M12

DANGER



Tipping over of the product may cause injury or death.
The following must be observed when assembling the product:

- the ground must be level and sufficiently firm
- never climb on the product during assembly, as it is only stable when assembled

Attention



During assembly, the following must be observed:

- suitable protective clothing
- keep hands and feet away from potentially dangerous areas
- all work must be carried out carefully

Hazard



Hazard Classification
Hazard type and result
> Measures for prevention and defense
Danger to life and limb when installing and using the product

Required tools for assembly:

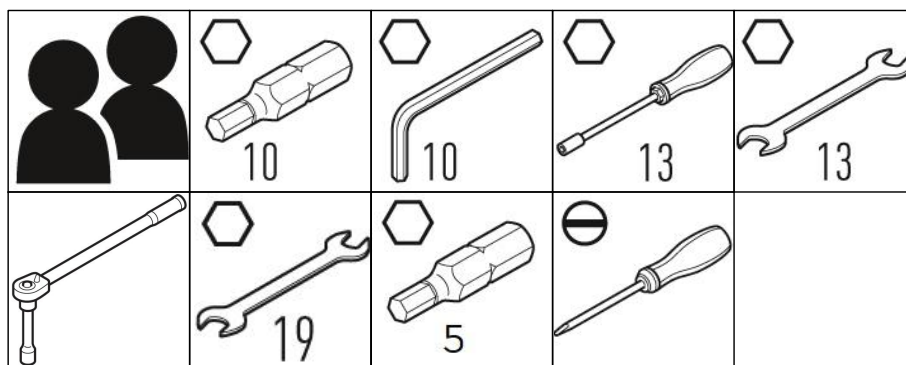

4 Assembly

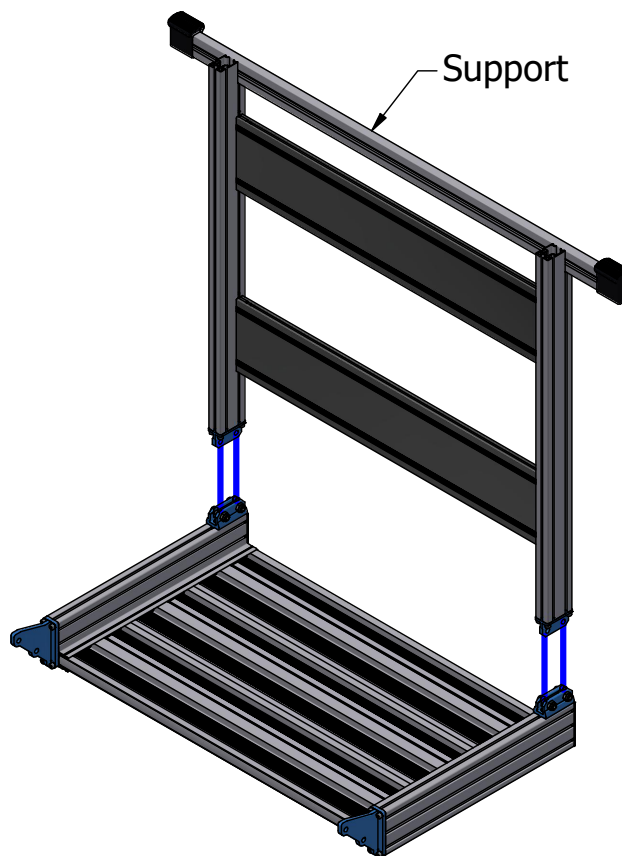
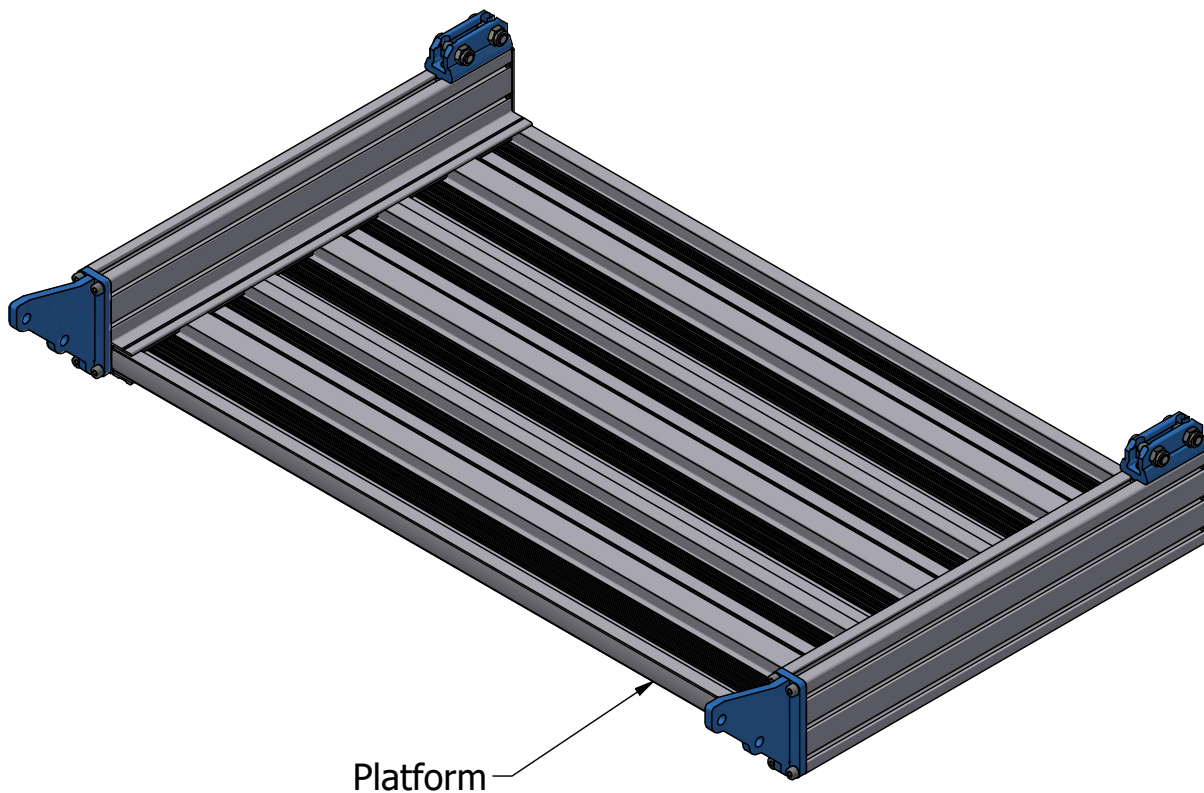

4 Assembly

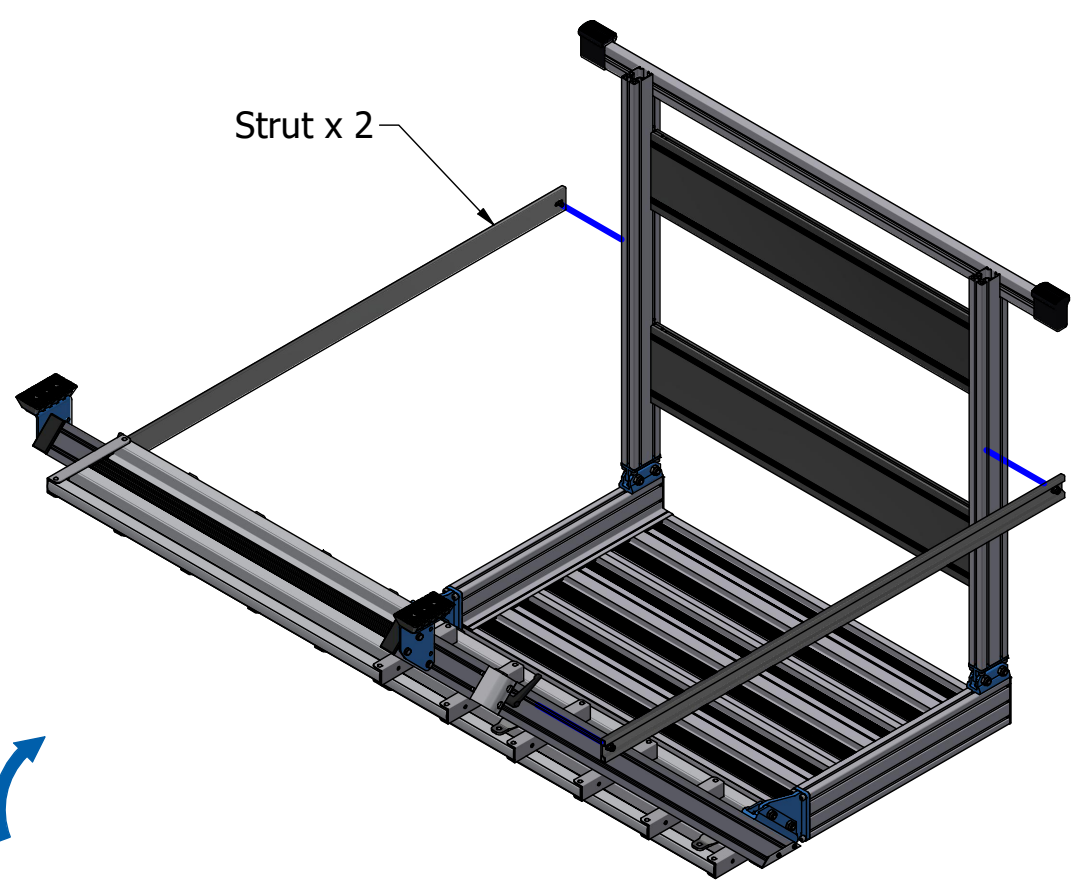

4 Assembly

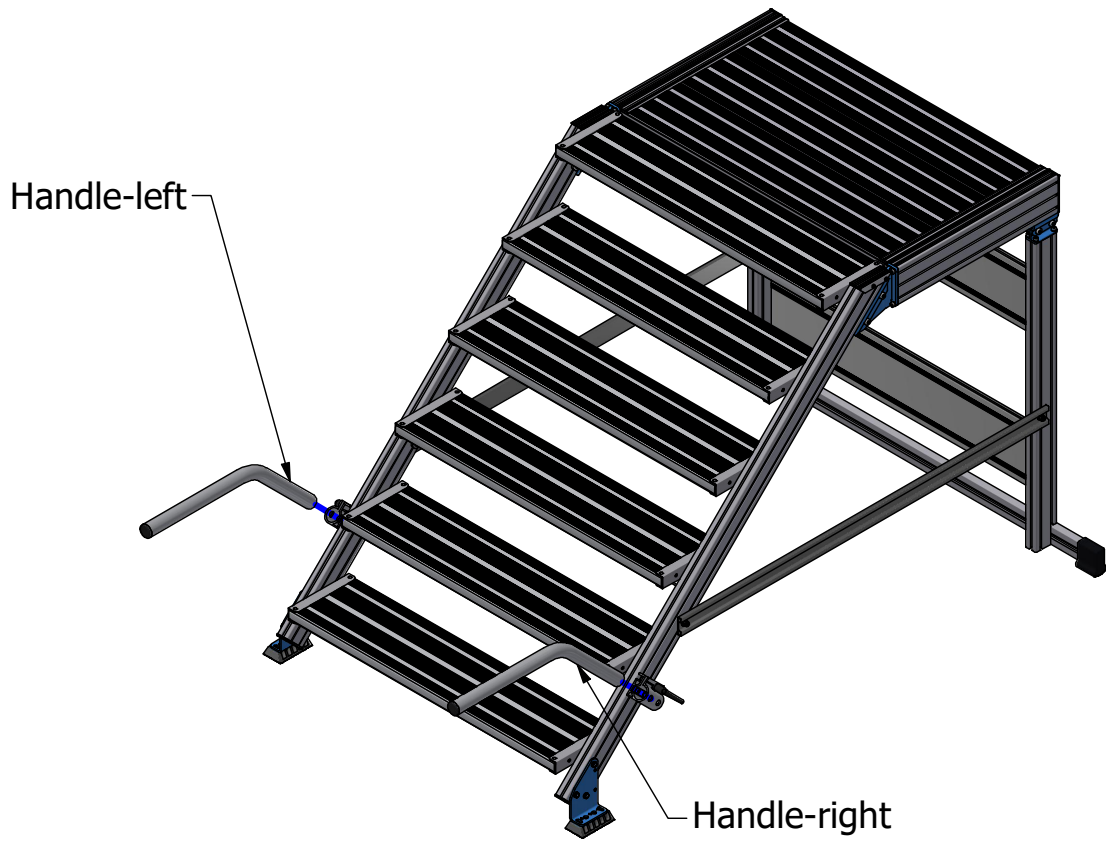

5 Usage

The following must be checked before use:

- Are all delivered parts installed in the product?
- Is the product being used on level ground?
- Is the product in perfect condition?

The product may only be used if the answer to all questions is 'yes'.

6 Maintenance and repair

Cleaning: with water and detergent.

Due to the increased risk of slipping caused by water, the product can only be reused after drying.

Inspection:

A specialist must regularly check the usability and safety of the product and then prepare a report:

- inspections must be carried out at specified intervals
- installed components must be checked according to the provided drawings
- completed and signed reports must be kept
- in the event of any malfunction, damage, manipulation or variations thereof, the responsible person and the manufacturer must be notified immediately

6 Maintenance and repair

Part	Action to be performed	Interval	Act
Handle	Checking the screw connections for tightness	yearly	inspection
	Checking the weld for cracks	yearly	inspection
	Checking for damage and deformation	yearly	inspection
	Checking for completeness and functionality	yearly	inspection
	Inspection of safety devices	monthly	inspection
Steps	Checking the screw connections for tightness	yearly	inspection
	Cleaning the surfaces	yearly	maintenance
	Checking for damage and deformation	yearly	inspection
Platform	Cleaning the surfaces	monthly	maintenance
	Check for damage and deformation	yearly	inspection

7 Spare parts list



PARTS LIST			
ITEM	OBJECT_IDENT	DESCRIPTION	QTY
1		Platform	1
2		Stairs	1
3		Support	1
4		Strut	2
5		Handle-right	1
6		Handle-left	1