

Spill Containment Tray (60 l)

Technical Data

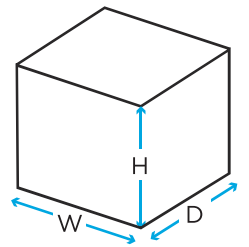
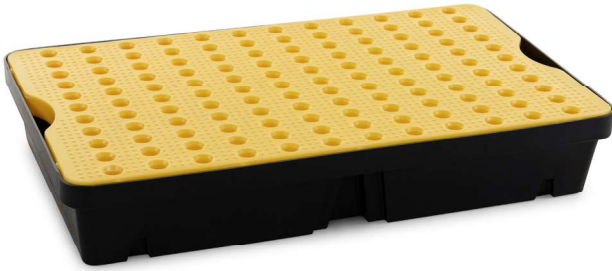

Platforms are also available in **black** and **green**, minimum order quantities may apply.

Colour	H x W x D (mm)	Platform (mm)	Weight (kg)	Capacity (l)	Max. load (kg)	DIBt
ST1-60-YE-BK	175 x 1000 x 600	40 x 990 x 590	9	60*	200	-
ST1-60-BK-BK/D		-	5	87	-	Z.40.22-485
ST1-60-B-BK				60*		Z.40.22-485
ST1-60-B-BK/D						

*Measured to underside of platform

Spill Containment Tray (60 I)

Technical Data

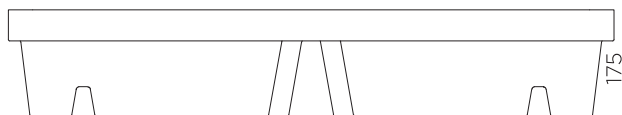
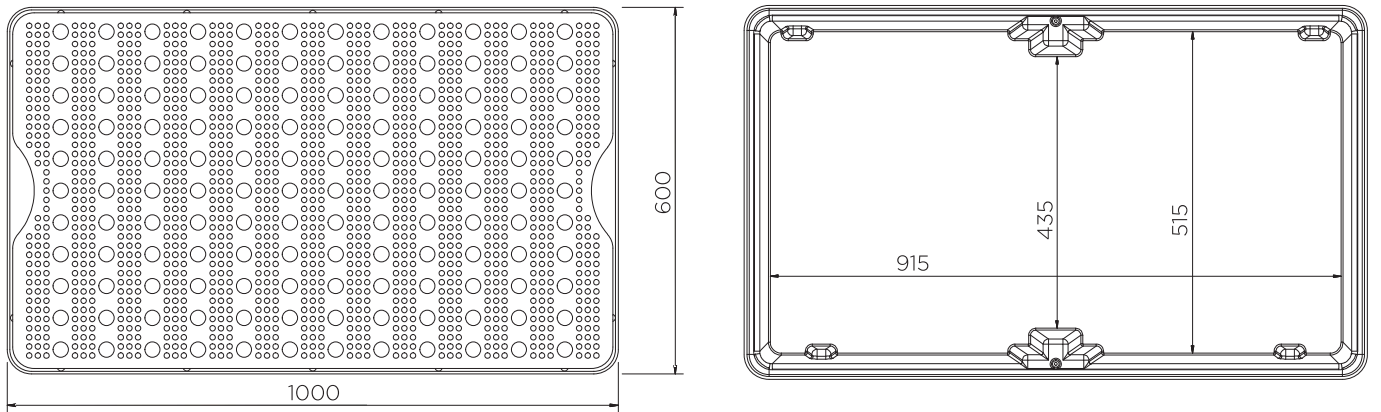
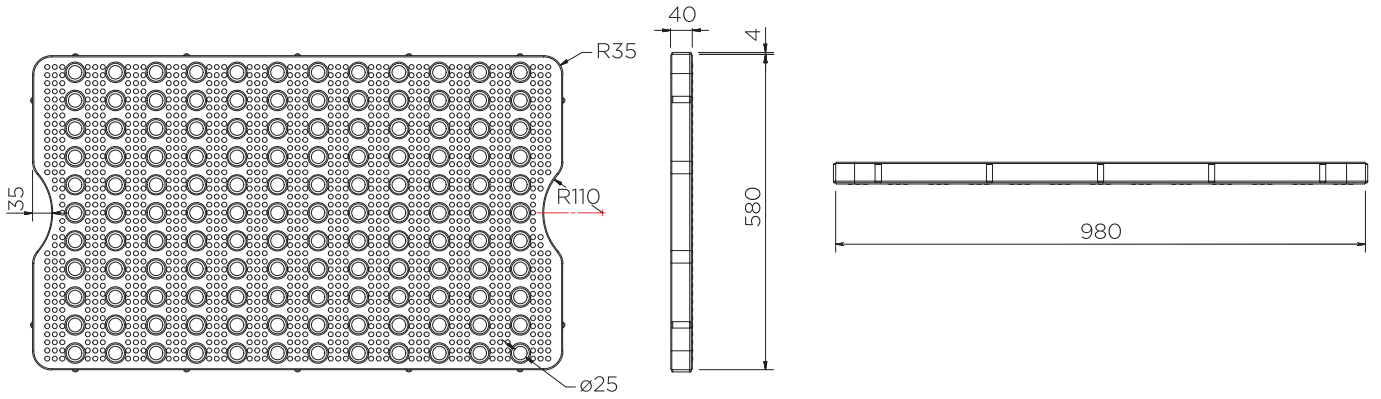

Spill Containment Tray (60 I)

Technical Data

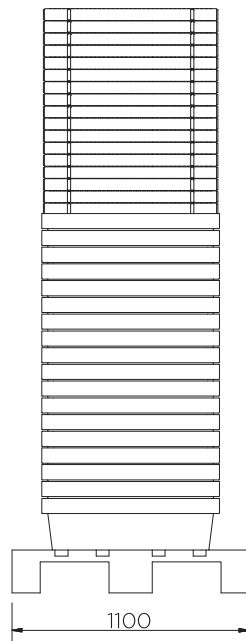
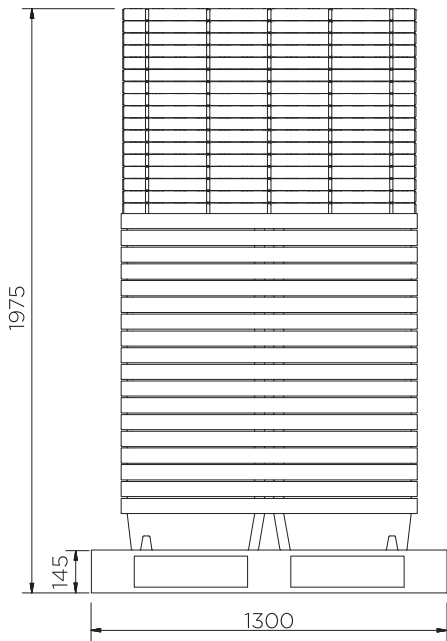

ST1-60-XX-BK

Pieces per pallet	18
20' container	198
40' high cube container	450
13.6 m trailer	595

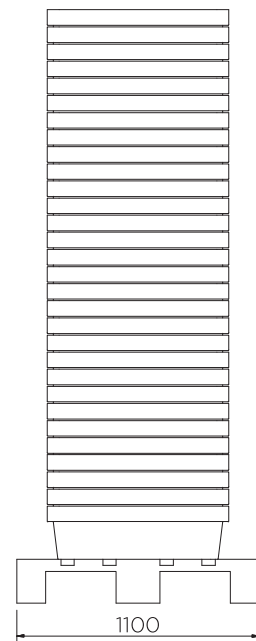
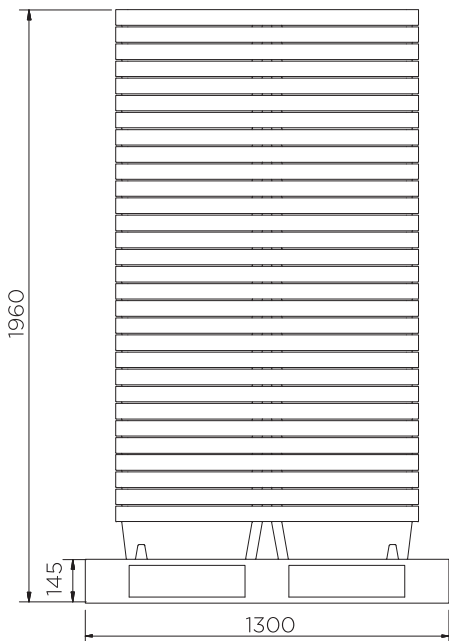

ST1-60-B-BK

Pieces per pallet	30
20' container	330
40' high cube container	750
13.6 m trailer	990

The information is to our best knowledge true and accurate but all recommendations or suggestions are made without guarantee.