

JSXZ, Zero Differential Pressure Type Pilot Operated JSXZ31-CN03F-JDS

Datasheet

General series information

- Applicable fluid: air, water, oil
- Flow rate up to 460 l/min (water)
- Orifice diameter: 10 to 25 mm
- Port size: 1/4" to 1"
- Body material: stainless steel, brass and aluminium
- Coil material: stainless steel
- Enclosure: IP67.

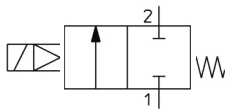

Directional control valve 2/2-way valve, closed normal position With a combination control by solenoid and pilot valve control Return with mechanical control spring

Standard specifications

Oil-free Option	None
Bracket	None
Electrical Entry	DS (DIN Terminal, w/Surge Voltage Suppressor)
Body Material	C (Brass)
Size	3 (30)
Rated voltage	J (230 VAC)
Port Size	03 (3/8)
Seal Material	N (NBR)
Thread Type	F (G)
Maximum temperature of pressure medium	60 °C
Minimum temperature of pressure medium	Air: -10 °C, Water: 1 °C, Oil: -5 °C
Maximum operating pressure	1 MPa
Proof pressure	2.0 MPa
Maximum ambient temperature	60 °C
Minimum ambient temperature	-20 °C
Conform to the European RoHS Directive	Conform

Enclosure	IP67 (IP65 for the DIN terminal)
F597-Allowable_voltage	±10% of rated voltage
F598-Allowable_leakage	5 % or less of the rated voltage
F599-Apparent_power	9.5 VA
F601-Temperature_rise	70 °C
F603-Valve_Leakage	Air: 1 cm ³ /min, Water and Oil: 0.1 cm ³ /min
Weight	0.750 Kg

Dimensions

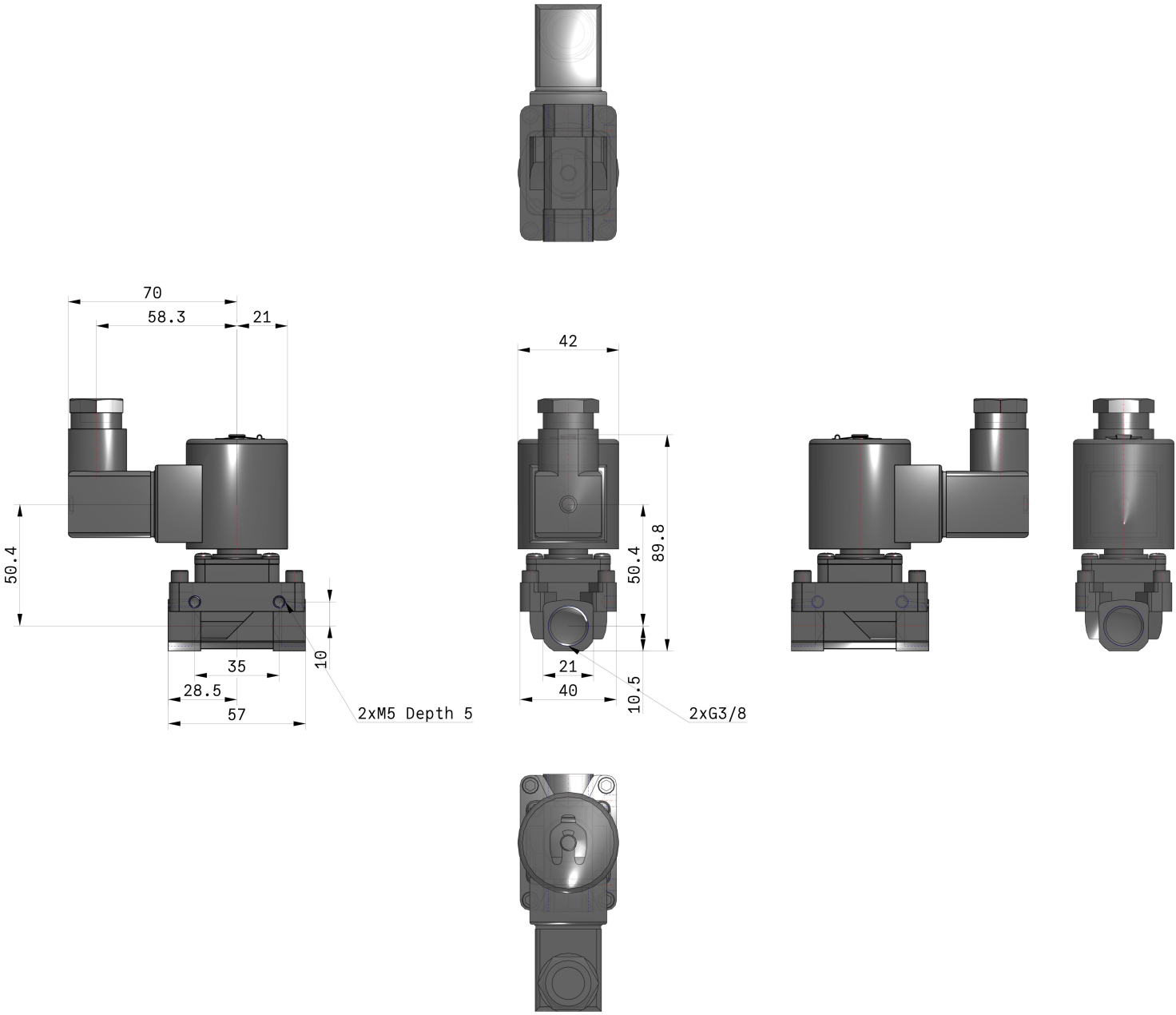

Specifications are subject to change without prior notice and any obligation on the part of the manufacturer.

Constructions

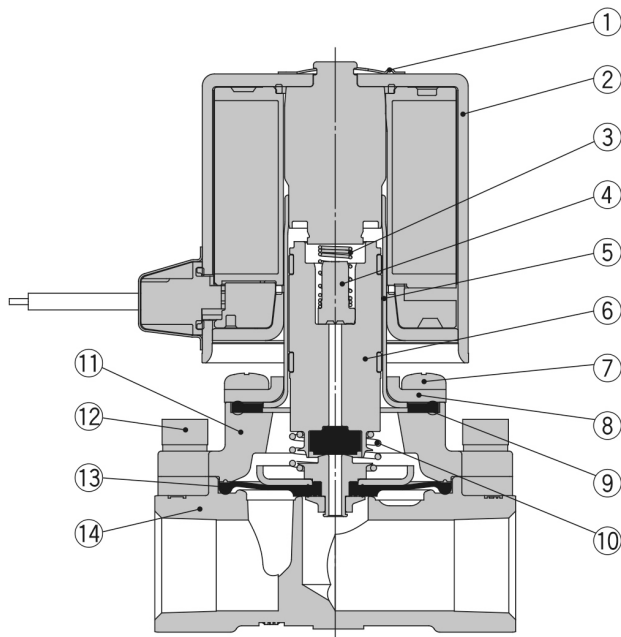

Component Parts

No.	Description	Material		
			Brass	Stainless
1	Clip	Stainless steel		
2	Solenoid coil	Stainless steel, Cu, Resin		
3	Spring	Stainless steel		
4	Stopper	PPS		
5	Tube assembly	Stainless steel		
6	Armature assembly	Stainless steel, PPS, NBR (FKM, EPDM)		
7	Mounting screw	Fe		
8	Bonnet	Stainless steel		
9	Gasket	NBR (FKM, EPDM)		
10	Lift spring	Stainless steel		
11	Bonnet	Aluminium	Brass	Stainless
12	Bolt	Fe		
13	Diaphragm assembly	Stainless steel, NBR (FKM, EPDM)		
14	Body	Aluminium	Brass	Stainless

*1 Size 30 only

Additional information

Catalogue	JSX-Da_EU.pdf
Declaration of conformity	newDoC_JSXZ_TF122130EN.pdf
Installation manuals	IM_JSXZ_TF222-050EN-A.pdf