

C(D)85, ISO Standard Cylinder, Double Acting, Single Rod CD85N16-200C-B

Datasheet

The C85 series conforms to ISO 6432 and CETOP RP52P. The C85 is available in bore sizes 8mm through 25mm with standard strokes ranging from 10mm through 300mm. A unique rod packing design prevents entry of dust and the effectiveness of the seal is such that the C85 is suitable for use in extremely dusty environments. With abrasion resistant packings and replaceable nose seals, the C85 offers exceptional service life.



Double-acting cylinder with cushioning adjustable at both ends, single piston rod

Standard specifications

Magnet	D (Built-in)
Mounting	N (Basic Integrated Clevis)
Bore Size	Ø16 mm
Stroke	200
Cushion	C (Air Cushion)
Rod Boot	None
Auto Switch Mounting Type	B (Band)
Rod End Options	None
Temperature Resistance	None
Low Speed	None
Stainless Steel	None
Long Stroke	None
-	Compressed Air
Maximum temperature of pressure medium with magnet	80 °C
Minimum temperature of pressure medium with magnet	-20 °C
Maximum operating pressure	1 MPa
Minimum operating pressure	0.05 MPa
Proof pressure	1.5 MPa
Maximum ambient temperature with magnet	80 °C
Minimum ambient temperature with magnet	-20 °C

Pneumatic input connection	M5
Pneumatic output connection	M5
Theoretical cylinder force, advance stroke (at 0.5 MPa)	100.6 N
Theoretical cylinder force, return stroke (at 0.5 MPa)	86.4 N
Maximum piston speed	1,500 mm/s
Type of cushioning	Air cushion
Piston rod end	External thread
Male thread of rod end	M6
Minimum piston speed	50 mm/s

Dimensions

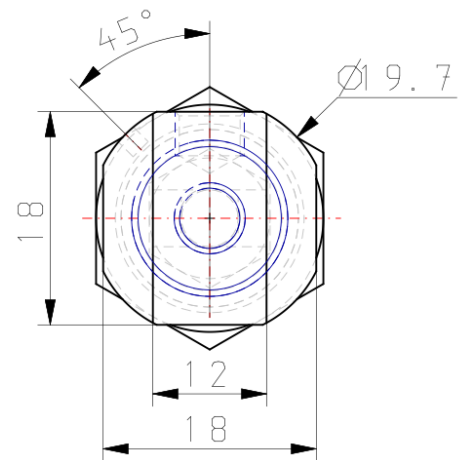
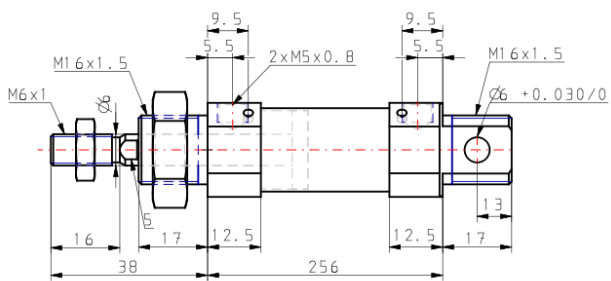

($\phi 20$, $\phi 25$)

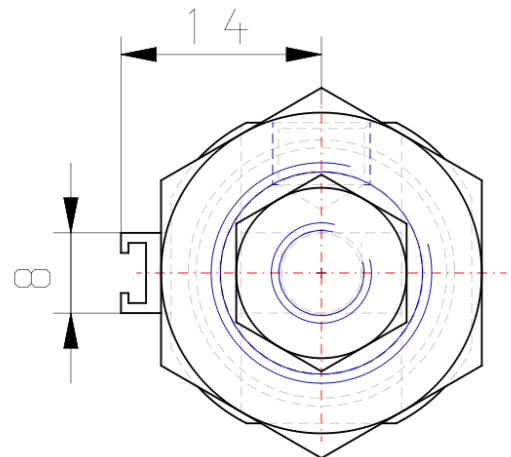
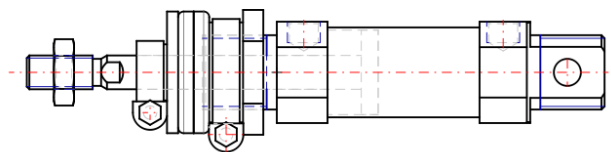

Constructions

Double acting: Single rod C□85□10 to 16 Air cushion (Disassembly is not possible)

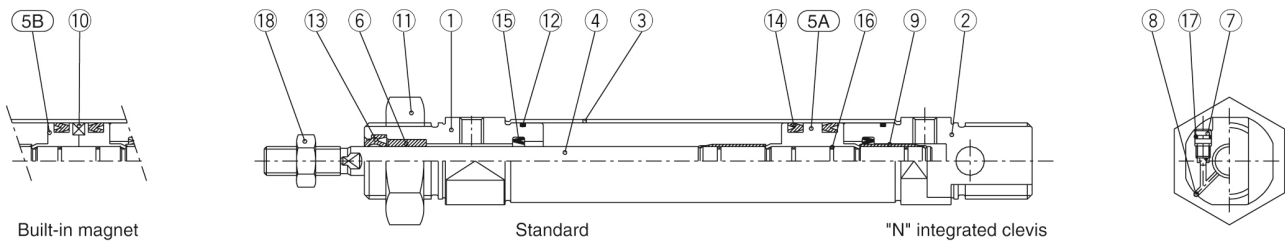

Component Parts

No.	Description	Material	Quantity	Remarks
①	Rod cover	Aluminum alloy	1	White anodized
②	Head cover N	Aluminum alloy	1	White anodized
③	Cylinder tube	Stainless steel	1	
④	Piston rod	Stainless steel	1	
⑤A	Piston A	Brass	1	
⑤B	Piston B	Brass	2	(Switch style piston)
⑥	Bush	Sintered bronze	1	
⑦	Cushion needle	Stainless steel	2	
⑧	Steel ball	Bearing steel	2	

No.	Description	Material	Quantity	Remarks
⑨	Cushion ring	Brass	2	
⑩	Magnet		1	
⑪	Mounting nut	Carbon steel	1	Nickel plated
⑫	Tube gasket	NBR	2	
⑬	Rod seal	NBR	1	
⑭	Piston seal	NBR	2	
⑮	Check seal	NBR	2	
⑯	Piston gasket & cushion ring gasket	NBR	3	
⑰	Needle seal	NBR	2	
⑱	Rod end nut	Carbon steel	1	Nickel plated

Additional information

Catalogue

[C85_C75-A_EU.pdf](#)