

C(D)85, ISO Standard Cylinder, Double Acting, Single Rod CD85N20-15-B

Datasheet

The C85 series conforms to ISO 6432 and CETOP RP52P. The C85 is available in bore sizes 8mm through 25mm with standard strokes ranging from 10mm through 300mm. A unique rod packing design prevents entry of dust and the effectiveness of the seal is such that the C85 is suitable for use in extremely dusty environments. With abrasion resistant packings and replaceable nose seals, the C85 offers exceptional service life.



Double-acting, single-rod cylinder

Standard specifications

Magnet	D (Built-in)
Mounting	N (Basic Integrated Clevis)
Bore Size	Ø20 mm
Stroke	15
Cushion	Rubber Cushion
Rod Boot	None
Auto Switch Mounting Type	B (Band)
Rod End Options	None
Temperature Resistance	None
Low Speed	None
Stainless Steel	None
Long Stroke	None
-	Compressed Air
Maximum temperature of pressure medium with magnet	80 °C
Minimum temperature of pressure medium with magnet	-20 °C
Maximum operating pressure	1 MPa
Minimum operating pressure	0.05 MPa
Proof pressure	1.5 MPa
Maximum ambient temperature with magnet	80 °C
Minimum ambient temperature with magnet	-20 °C

Pneumatic input connection	G 1/8
Pneumatic output connection	G 1/8
Theoretical cylinder force, advance stroke (at 0.5 MPa)	157.1 N
Theoretical cylinder force, return stroke (at 0.5 MPa)	132.0 N
Maximum piston speed	1,500 mm/s
Type of cushioning	Rubber bumper
Piston rod end	External thread
Male thread of rod end	M8
Minimum piston speed	50 mm/s
Weight	0.204 Kg

Dimensions

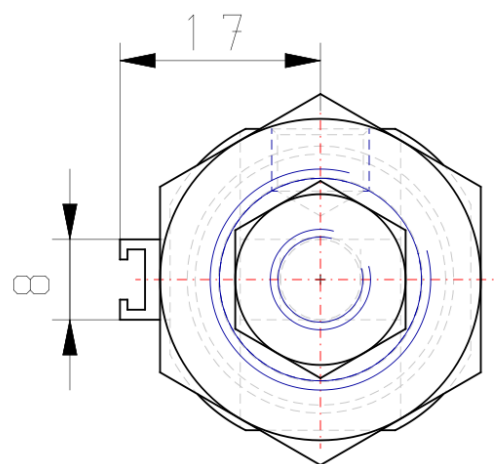
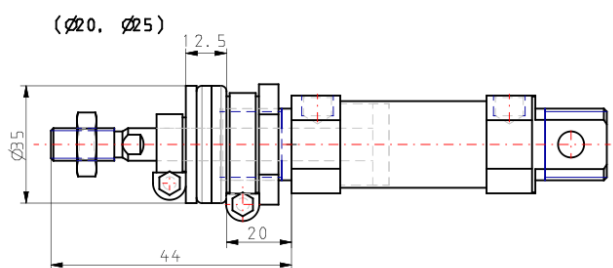
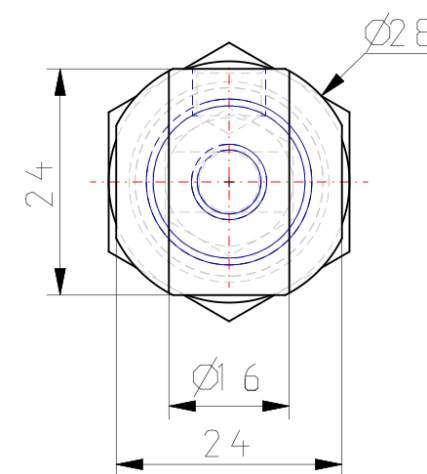
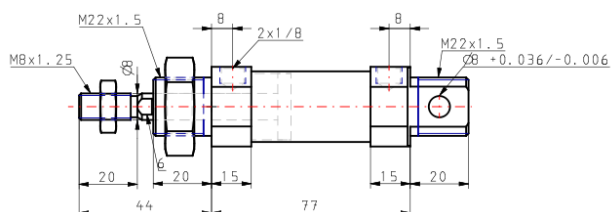

Constructions

C□85□20, 25 Rubber bumper



Component Parts

No.	Description	Material	Quantity	Remarks
①	Rod cover	Aluminum alloy	1	White anodized
②A	Head cover N	Aluminum alloy	1	White anodized
②B	Head cover E	Aluminum alloy	1	White anodized
②C	Head cover F	Aluminum alloy	1	White anodized
②D	Head cover Y	Aluminum alloy	1	White anodized
③	Cylinder tube	Stainless steel	1	
④	Piston rod	Carbon steel	1	Hard chrome plated
⑤	Piston	Aluminum alloy	1	Chromated
⑥	Plain washer	Carbon steel	1	Nickel plated
⑦	Bushing	Sintered bronze	1	
⑧	Bushing	Sintered bronze	2	

* Stainless steel (Non-rotating rod)

No.	Description	Material	Quantity	Remarks
⑨	Retaining ring	Carbon steel	1	Nickel plated
⑩	Retaining ring	Carbon steel	2	
⑪	Magnet		1	(Switch style only)
⑫	Wear ring	Phenolic resin	1	
⑬	Bumper A	Urethane	1	
⑭	Bumper B	Urethane	1	
⑮	Piston gasket	NBR	1	
⑯	Rod seal	NBR	1	
⑰	Piston seal	NBR	1	
⑱	Rod end nut	Carbon steel	1	Nickel plated
⑲	Mounting nut	Carbon steel	1	Nickel plated

Additional information

Catalogue

[C85_C75-A_EU.pdf](#)